



Min. 15 kg
Max. 150 kg



Min. -10°C
Max. 50°C



+ 2.400 m
- 50 m



Min. 0%
Max. 100%

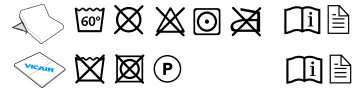

1

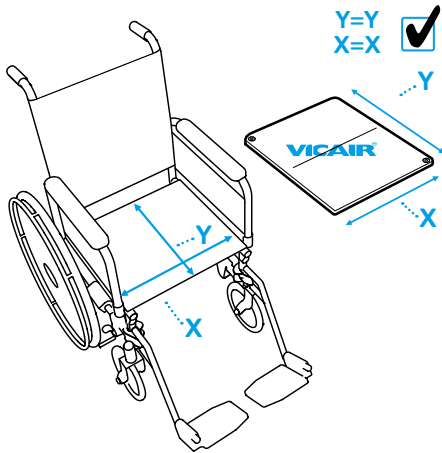

2

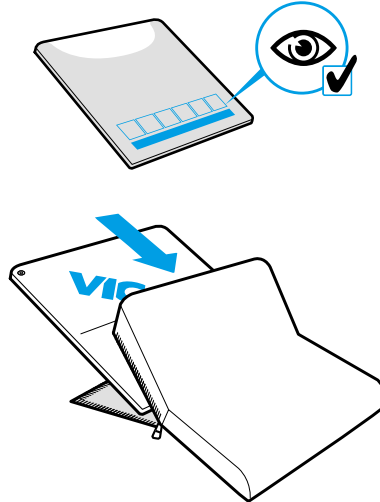

3

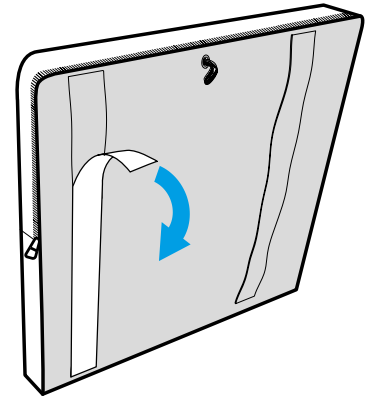

4

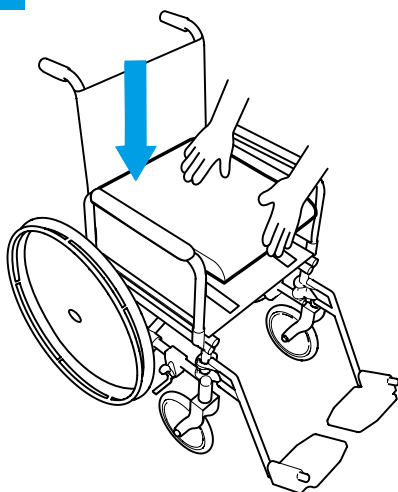

5

5 min.

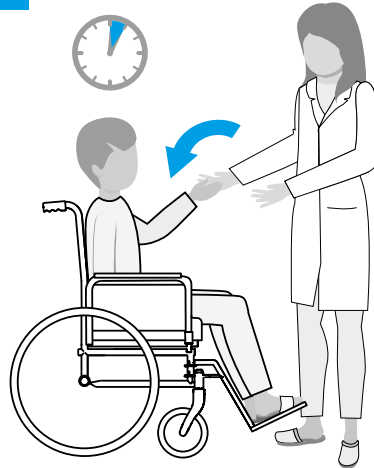

6

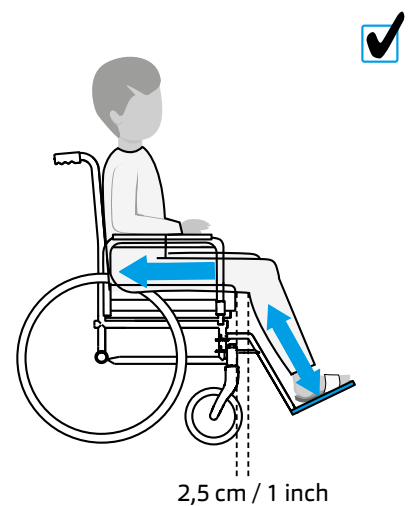

7

5 min.



Min.
2,5 cm / 1 inch

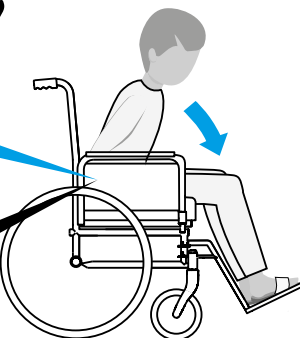
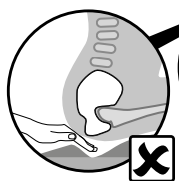
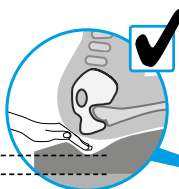

8

15 min.

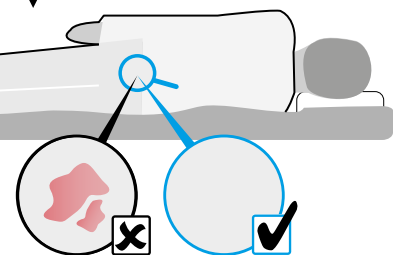

Vicair B.V. Bruynvisweg 5 1531 AX Wormer The Netherlands
info@vicair.com ▲ vicair.com



8 717261 040028

070053-REV08/2017